

CUTA1250113B

REVISIONS			
REV	DATE	BY	DESCRIPTION
A1	11-17-22	KD	INITIAL RELEASE

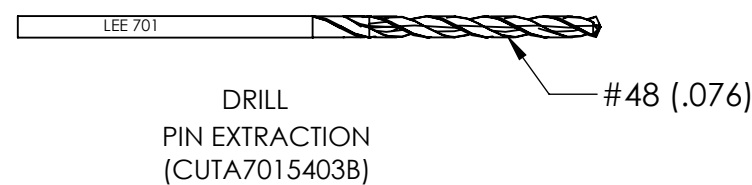
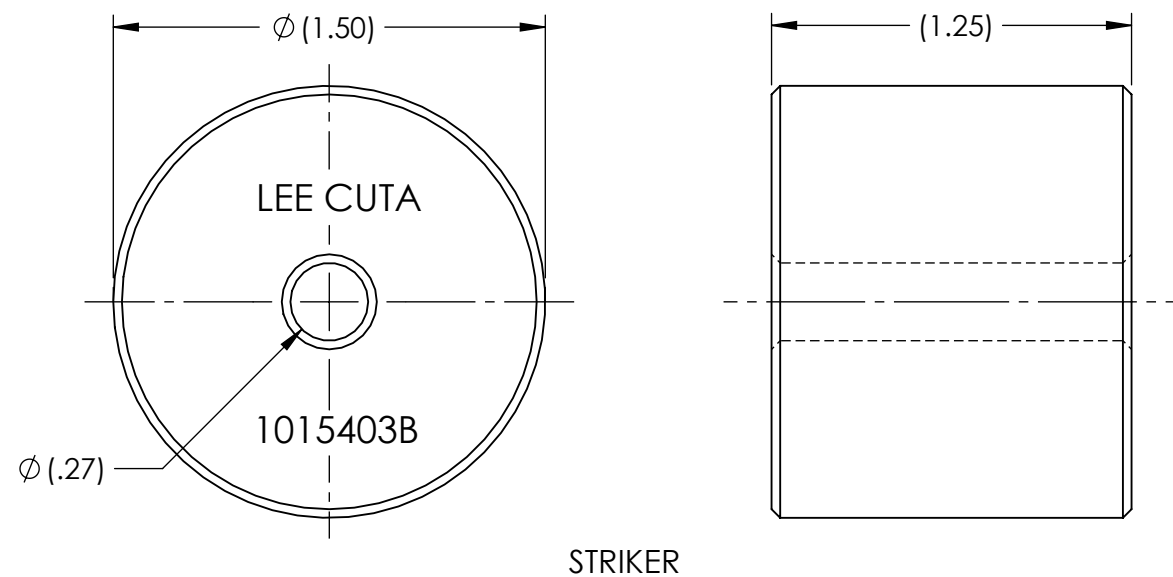
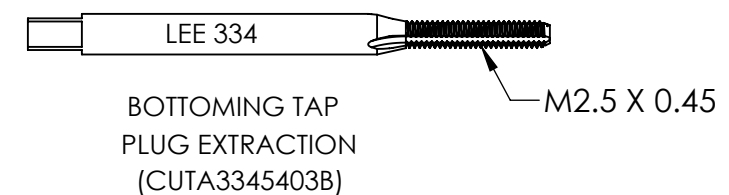
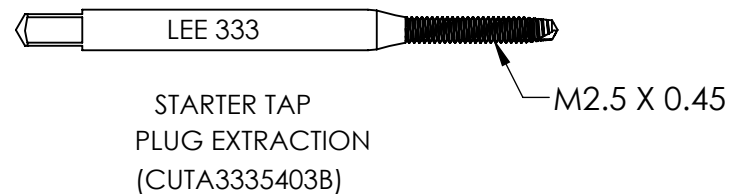
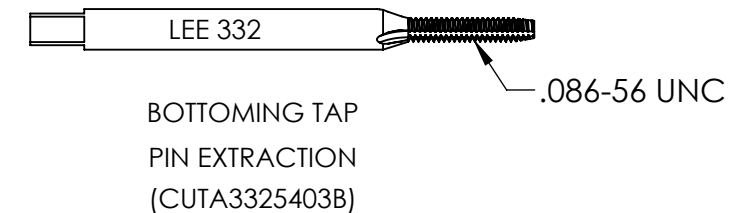
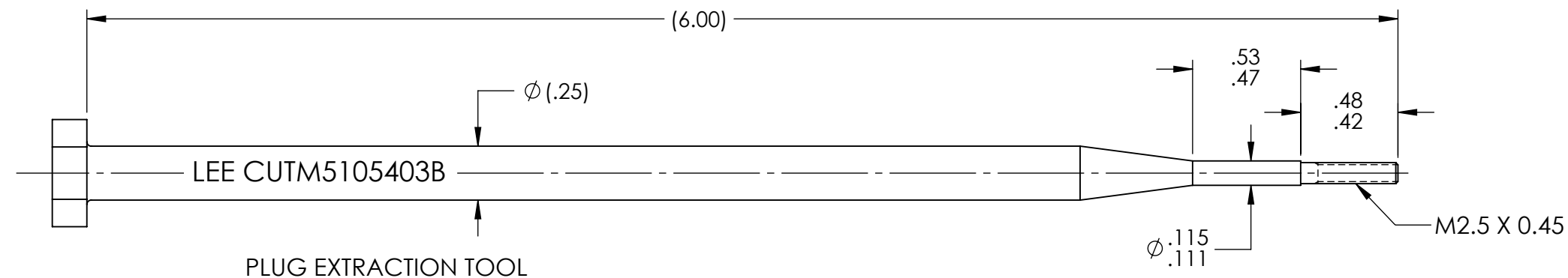
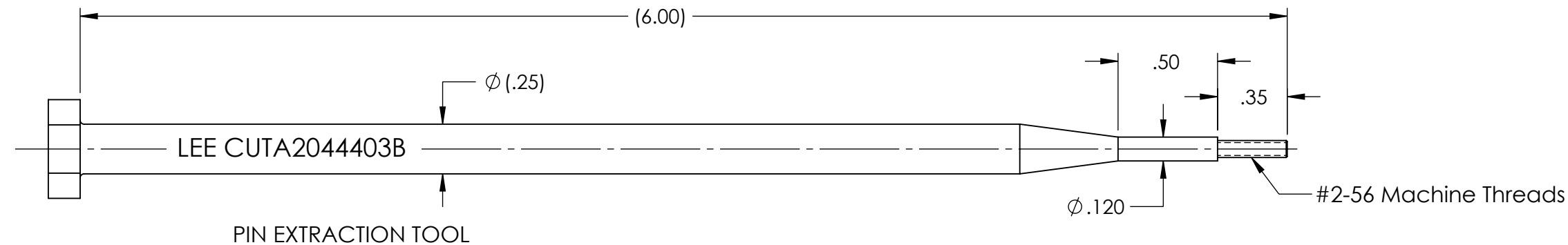

NOTES:

- MINIMUM OF 3 THREADS OF ENGAGEMENT TO EXTRACT PIN AND 4 THREADS OF ENGAGEMENT TO EXTRACT PLUG.
- EXTRACTION TOOL SET FOR PLGA1251350A AND PLGA1351350A.

WARNING-EXPORT CONTROLLED BY: EAR [50 USC 2401], THIS DRAWING: EAR99
PRODUCT/TECHNOLOGY CLASSIFICATION: EAR99/EAR99

PROPRIETARY NOTICE
This document contains confidential, trade secret information which is proprietary to The Lee Company, and is submitted upon the express condition that neither it, nor our products, will be used directly or indirectly in any way detrimental to the interests of The Lee Company, such as disclosure to others or replication of our products, and/or in violation of 18 U.S.C. 1905 (TSA), 5 U.S.C. 552 (FOIA), E.O. 12600 of 6/23/87, 18 U.S.C. 1832, and C.G.S.A. (CT) Chapter 625 sec. 35-50 thru 35-58.

CUTD1250113
REFERENCE

DWG. NO. CUTA1250113B	NOTES AND DIMENSIONS SHOWN HERE ON ARE FOR INSPECTION IDENTIFICATION ONLY. ALL MANUFACTURING RIGHTS RESERVED.	DRAWN	K D	11-17-2022	LEE TOOL SET, MP35N, EXTRACTION, .125		
	UNLESS OTHERWISE SPECIFIED EXT. COR. BREAK: INTERNAL FILLET R: SURFACE FINISH ALL OVER DIMENSIONS ARE IN INCHES TOLERANCES 2 PLACES 3 PLACES ANGLES ±.015 ±.005 ±5°	CHK'D	B W	01-19-2024			
		APP'D	R M	01-23-2024	THE LEE COMPANY WESTBROOK, CT 06498		
		MATL	H.T.	FINISH			SIZE B
				SCALE NONE		SHEET 1 OF 1	