

## Installation Procedure

### IP RI FORWARD 5.5

**REVISION HISTORY**

Revision	Date	Change
A	11/1/2019	Initial Release
B	5/15/2020	Title/Description Change
C	6/15/2023	Added Appendix D

*Installation Procedure, Lee Orifice, 5.5 mm,  
Forward, Insert*

# FACTORY INSTALLATION PROCEDURE

**Table of Contents**

**1. OVERVIEW**.....2

**2. INSTALLATION HOLE REQUIREMENTS**.....2

**3. INSTALLATION**.....3

3.1. *INSTALLATION EQUIPMENT* .....4

3.2. *STANDARD FACTORY INSTALLATION*.....4

**4. APPENDICES**.....5

4.1. *APPENDIX A: DIAGRAM OF FACTORY INSTALLATION*.....5

4.2. *APPENDIX B: INSTALLATION HOLE DIMENSIONS*.....6

4.3. *APPENDIX C: INSTALLATION TOOL DIMENSIONS*.....6

4.4. *APPENDIX D: PROMESS, INC. PRESS INFORMATION* .....7

# 1. Overview

This procedure is intended to provide process guidelines for proper installation of Lee Orifice, 5.5 mm, Forward, Insert product. This procedure is applicable for both Forward Screened and Forward Unscreened 5.5 mm Insert Orifice products. Section 2 provides an overview of the installation hole requirements. Section 3 contains the installation procedure. Section 4 contains a diagram of proper orientation and position of the product with respect to the installation hole and installation tool.

Compliance with this installation procedure will ensure optimal product performance. Please contact your local Lee Company Sales Representative for questions concerning installation of Lee Company products.

## 2. Installation Hole Requirements

The Lee Orifice, 5.5 mm, Forward, Insert product is purposely designed to perform well under adverse conditions. Therefore, the installation hole specifications outlined in this section should be followed precisely to ensure proper function of the product's expansion sealing features. Installation forces and pressure ratings are based on installations in aluminum housings or manifolds.

Installation hole specifications as found on Lee Installation Drawing 1INST013800S (Appendix B) will ensure proper operation of the Lee Orifice, 5.5 mm, Forward, Insert product. The hole should be clean, dry and free of burrs. Surface finish should not exceed 1.6 $\mu$ m (Ra) with no longitudinal surface defects. Surface finish requirements must be given special attention. The expansion section of the Lee Orifice, 5.5 mm, Forward, Insert product seals and retains the product in the hole. A smooth machined surface where the product interacts with the hole is needed to seal and retain the product properly.

The Lee Company does not recommend the use of coatings or surface treatments in the area of the installation hole where the product is to be installed. These may reduce product retention.

### 3. Installation

**Installation Overview** – All Lee Orifice, 5.5 mm, Forward, Insert product use a pin to expand a grooved section of the insert's body into the housing wall to affect a seal and retain the component. The pin, which has been pre-installed, is driven into the body. The insert is pre-lubricated for proper installation. Do not clean prior to installation.

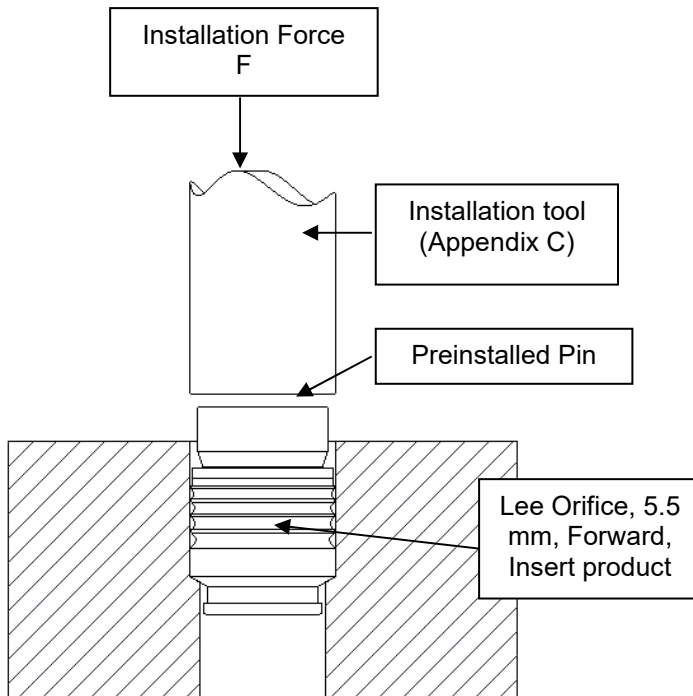

1. The Lee Orifice, 5.5 mm, Forward, Insert product is inserted into the installation hole with the pin end up as shown.
2. The installation tool (Appendix C) which is aligned with the installation hole, approaches the hole, and contacts the back of the pre-installed pin. The tool drives the pin into the Lee Orifice, 5.5 mm, Forward, Insert product body with a force of 6130 Newtons maximum. Using friction and penetration, the lands bite into the housing material.

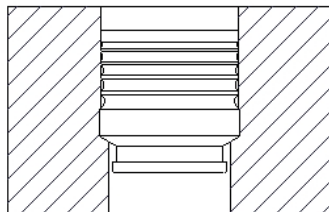

3. When the installation tool is retracted, the pin should be flush to within 0.25 mm above flush of the insert body.

### 3.1 Installation Equipment

The Lee Orifice, 5.5 mm, Forward, Insert product has been designed to be installed using pneumatic, hydraulic or servo type press equipment. An electric servo-press system is recommended for high volume production as it provides detailed feedback for better in process controls of the installation process. The housing in which the component is to be installed should be held stationary on a solid surface. The Lee Orifice, 5.5 mm, Forward, Insert product is expanded by the insertion of the pre-installed and lubricated expansion pin using an installation tool under load. Adjust the press stroke to eliminate excess over travel as this may damage the Lee Orifice, 5.5 mm, Forward, Insert product. Adjust the press supply pressure to limit the maximum force to 6130 Newtons.

Insertion should be done using Lee Installation Tool CCRT0900120S p/n (see Appendix C). The tool and installation hole need to be concentric as shown in Diagram of Factory Installation Appendix A. See Appendix D for further information about the recommended electric servo-press system from Promess, Inc.

### 3.2 Standard Factory Installation (see Appendix A)

1. Firmly support the housing or manifold in which the Lee product is to be installed.
2. Insert the Lee Orifice, 5.5 mm, Forward, Insert product into the installation hole, pin end up, until it is seated on the bottom of the installation hole.
3. The installation force should be 6130 Newtons maximum using Lee Installation Tool (see Appendix C). The tool can approach the product at a rate of 20-35 mm/sec. The maximum speed of the tool during installation should be limited to 3 mm/sec.
4. Inspect the Lee Orifice, 5.5 mm, Forward, Insert product for proper installation by measuring the depth of the pin relative to the body. Installation is complete when the exposed ends (surfaces A and B) are flush to within 0.25 mm above flush of each other as shown in Appendix A (Post Installation).
5. Retract the tool and follow the same procedure for additional installations.

#### Factory Best Practices:

1. Examine the condition of the Installation Tool at appropriate intervals and replace if damaged or chipped.
2. Clean feed bowls once per day or more as needed.
3. Turn off vibratory feed bowl when the assembly station is idle, or if the feed rail is full of parts.
4. Use the minimum vibration setting necessary to advance the Lee product in the feed bowl to avoid damage and /or contamination.
5. If the Lee product is blown into the assembly area with compressed gas from a feed rail, minimize the pressure to prevent possible damage.

# 4 Appendices

## 4.1 Appendix A: Diagram of Factory Installation

(Section View of Hole, Lee Product and Installation Tool)

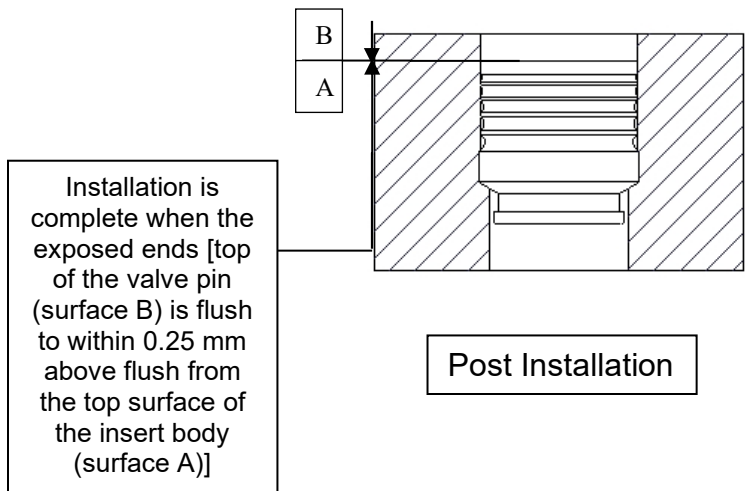
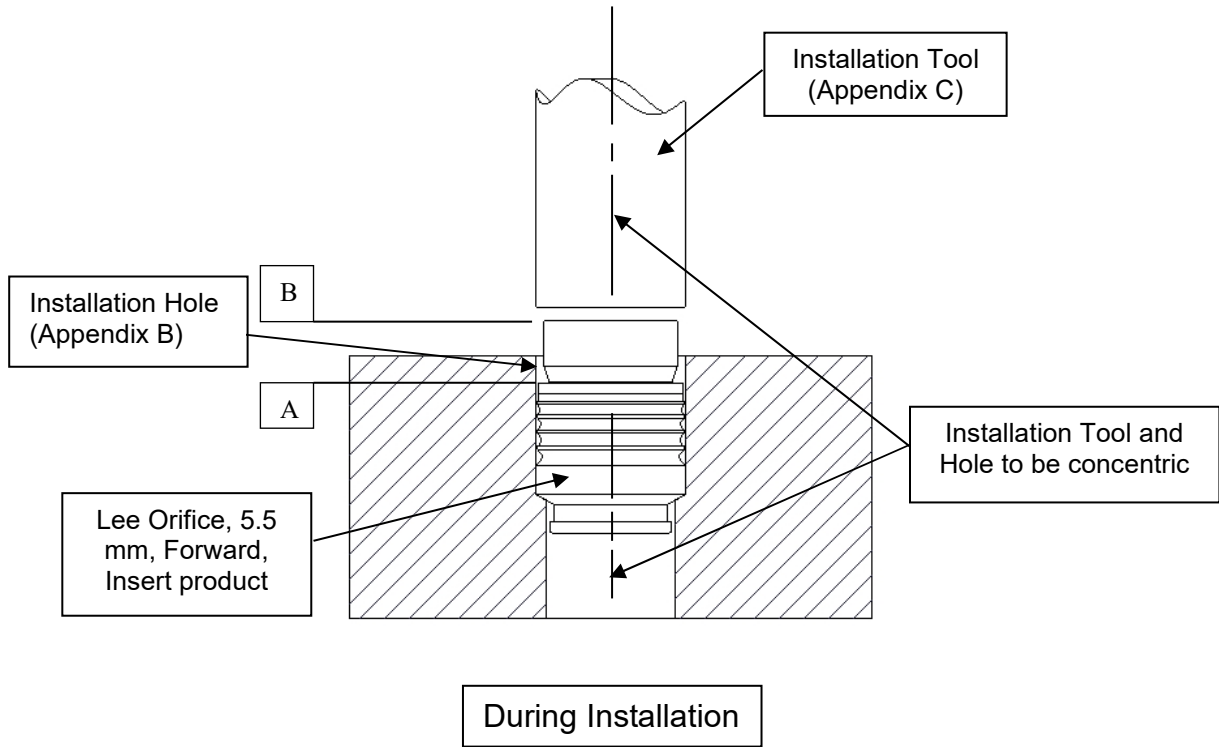

## 4.2 Appendix B Installation Hole

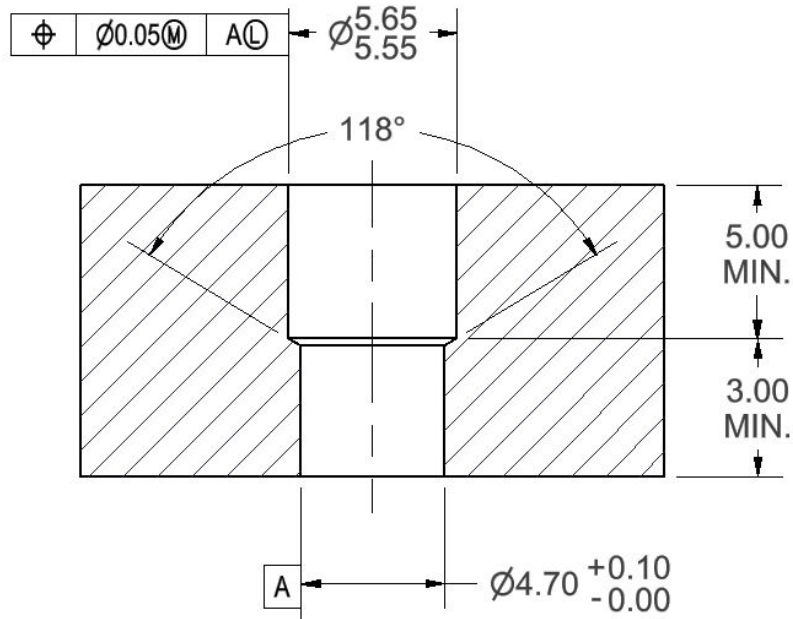

DIMENSIONS IN MILLIMETERS.

Hole should be clean, dry and free of burrs.

No longitudinal surface defects permitted.

No coatings or surface treatments in the area of the installation hole where the product is to be installed.

Refer to Lee Drawing No. 1INST013800S for complete specifications.

## 4.3 Appendix C Installation Tool

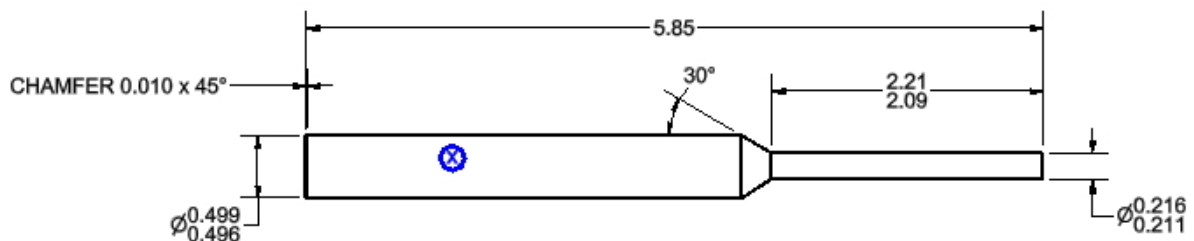

DIMENSIONS IN INCHES.

 Marked with part number and revision.

Refer to Lee Part No. CCRT0900120S for complete specifications.

## 4.4 Appendix D Promess, Inc. Press Information

**Contact:** Promess, Inc. 11429 Grand River Road, Brighton, MI 48116

Phone: (810) 229-9334, Web: [www.promessinc.com](http://www.promessinc.com)

### **Press Information:**

Number 8kN/200mm - FEMP12/200MP includes the following:

- 1-Press w/ integrated load cell, motor mounting plate and Motor
- 2-PreAmplifier (Connected to the Press Load Cell and Prox Switch)
- 3-MotionPRO Servo Amplifier
- 4-Motor Power Cable
- 5-Motor Encoder Cable
- 6-PreAmplifier Cable
- 7-MotionPRO software

