

Installation Procedure IP DLP 04

REVISION HISTORY

Revision	Date	Change
A	8/18/2022	Preliminary Release
B	9/7/2023	Updated Section 3.1 & Trademark

4 mm DL SERIES PLUG

FACTORY INSTALLATION PROCEDURE

Table of Contents

1. OVERVIEW	2
2. INSTALLATION HOLE REQUIREMENTS	2
3. INSTALLATION	3
3.1. <i>INSTALLATION EQUIPMENT</i>	4
3.2. <i>STANDARD FACTORY INSTALLATION</i>	4
4. APPENDICES	5
4.1. <i>APPENDIX A: DIAGRAM OF FACTORY INSTALLATION</i>	5
4.2. <i>APPENDIX B: TYPICAL INSTALLATION CURVES</i>	6
4.3. <i>APPENDIX C: INSTALLATION INDICATOR FEATURE (INSTALLATION PHOTOS)</i>	7
4.4. <i>APPENDIX D: INSTALLATION HOLE</i>	10
4.5. <i>APPENDIX E: INSTALLATION TOOL</i>	11
4.6. <i>APPENDIX F: PROMESS, INC. PRESS INFORMATION</i>	12

1. Overview

This procedure is intended to provide process guidelines for proper installation of 4 mm DL Series Plugs*. Section 2 provides an overview of the installation hole requirements. Section 3 contains the installation procedure. Section 4 contains a diagram of proper orientation and position of the product with respect to the installation hole and installation tool.

Compliance with this installation procedure will ensure optimal product performance. Please contact your local Lee Company Sales Representative for all questions concerning installation of Lee Company products.

2. Installation Hole Requirements

DL Series Plugs are purposely designed to perform well under adverse conditions. Therefore, the installation hole specifications outlined in this section should be followed precisely to ensure proper function of the product's expansion sealing features. Installation forces and pressure ratings are based on installations in aluminum housings or manifolds. Installations in other materials need to be reviewed with the Lee Company.

Installation hole specifications as found on Lee Installation Drawing (see Appendix D) will ensure proper operation of the 4 mm DL Series Plug. The hole should be clean, dry, and free of burrs. Surface finish should not exceed 1.6 μ m (Ra) with no longitudinal surface defects. Surface finish requirements must be given special attention. The expansion section with the Drive Locking® technology of the DL Series Plug seals and retains the product in the hole. A smooth machined surface where the product interacts with the hole is needed to seal and retain the product properly.

The Lee Company does not recommend the use of coatings or surface treatments around the installation hole where the product is to be installed. These may reduce product retention.

*Patent Pending

3. Installation

Installation Overview – All DL Series Plugs use a tool to expand the locking barb of the plug into the housing material to affect a seal and retain the component. The plug is pre-lubricated for proper installation. Do not clean prior to installation.

(Section View of Hole, DL Series Plug and Installation Tool)

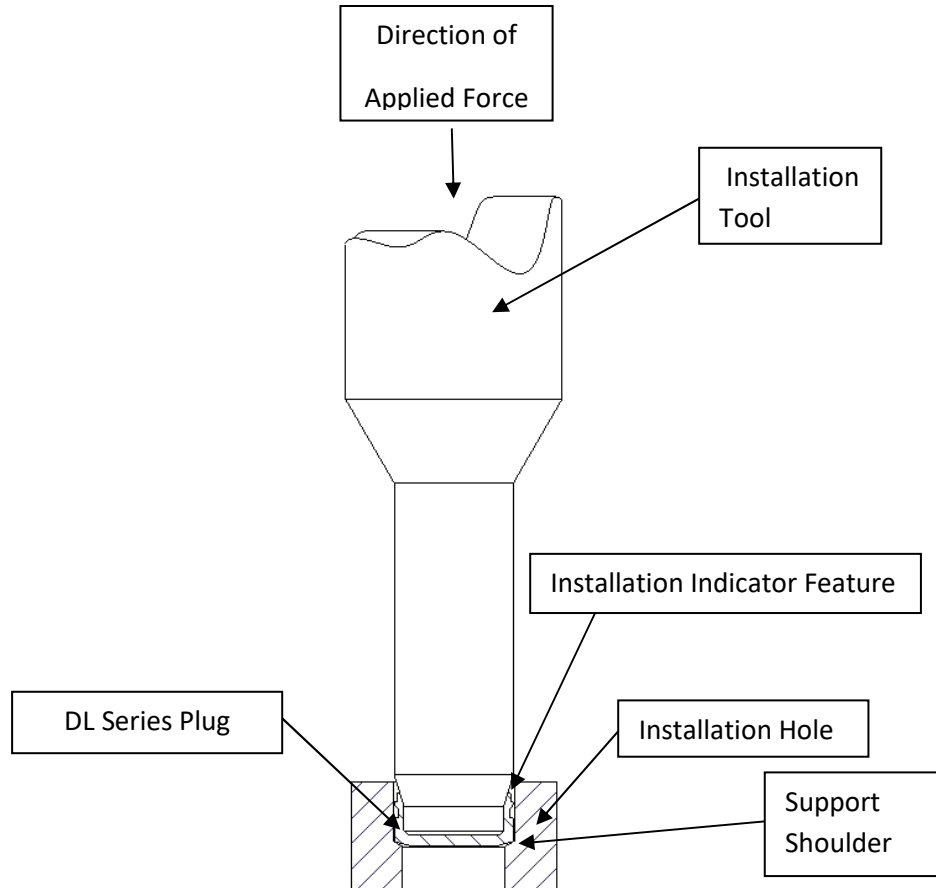

1. The DL Series Plug is inserted into the installation hole with the locking groove up as shown.
2. The installation tool (See Appendix E) is properly aligned with the installation hole as it approaches and contacts the plug. The tool expands the locking barb into the housing material with a non-impact force of 5 kN-6 kN. Typical installation curves can be seen in Appendix B.
3. When the installation tool is retracted, the installed product can be inspected. The installation indicator feature should be contacting the housing wall 360° around the plug. Example photos of the installation indicator feature can be seen in Appendix C.

3.1. Installation Equipment

The DL Series Plug has been designed to be installed using an electric servo-press system. Pneumatic or hydraulic systems may also be used. An electric servo-press system is recommended for high volume production as it provides detailed feedback for better in-process controls of the installation process. The housing in which the component is to be installed should be held stationary on a solid surface. The plug is retained by the expansion of the Drive Locking[®] technology using an installation tool under load. The press stroke should be adjusted to eliminate excess travel as this may damage the plug. Adjust the press supply pressure to limit the maximum load force to 6 kN.

Installation should be done using Lee Installation Tool (see Appendix E). The installation tool and installation hole need to be concentric to avoid damaging the housing. For further information about the recommended electric servo-press system from Promess, Inc. see Appendix F.

3.2 Standard Factory Installation (see Appendix A)

1. Firmly support the housing or manifold in which the DL Series Plug is to be installed.
2. Insert the DL Series Plug into the installation hole, locking barb end up, until it is seated on the shoulder of the installation hole.
3. Apply a non-impact installation force between 5-6 kN using Lee Installation Tool. The tool can approach the product at a rate of 20-35 mm/sec. The maximum speed of the tool during installation should be limited to 3 mm/sec. Installation Tool Travel versus Installation Force can be plotted to ensure proper installation. See typical installation signature curves in Appendix B.
4. Retract the tool and inspect the DL Series Plug for proper installation by inspecting that the installation indicator feature is in contact with the housing material. If the installation indicator feature is not in contact with the housing material 360° around the part, then the installation is incomplete. See Appendix C for example photos. Camera and vision systems recommended for high volume production.
5. Follow the same procedure for additional installations.

Factory Best Practices:

1. Examine the condition of the Installation Tool at appropriate intervals and replace if damaged or chipped.
2. Clean feed bowls once per day.
3. Turn off vibratory feed bowl when the assembly station is idle, or if the feed rail is full of parts.
4. Use the minimum vibration setting necessary to advance valves in the feed bowl.
5. The DL Series Plug is designed to be automatically fed using simple feed bowl and rail systems.

4. Appendices

4.1. Appendix A: Diagram of Factory Installation

(Section View of Installation Hole, DL Series Plug, and Installation Tool)

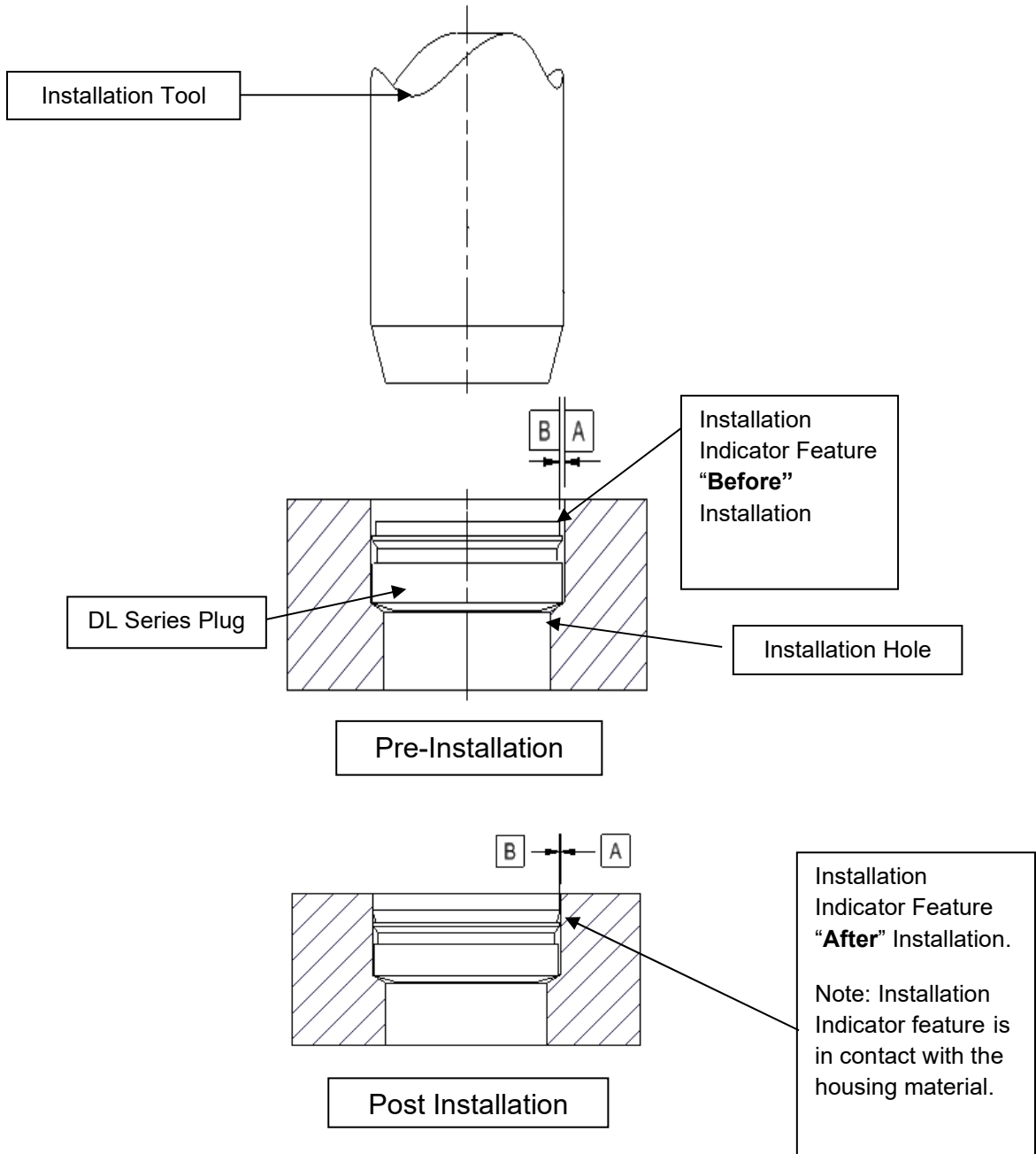

4.2. Appendix B: Typical Installation Curves

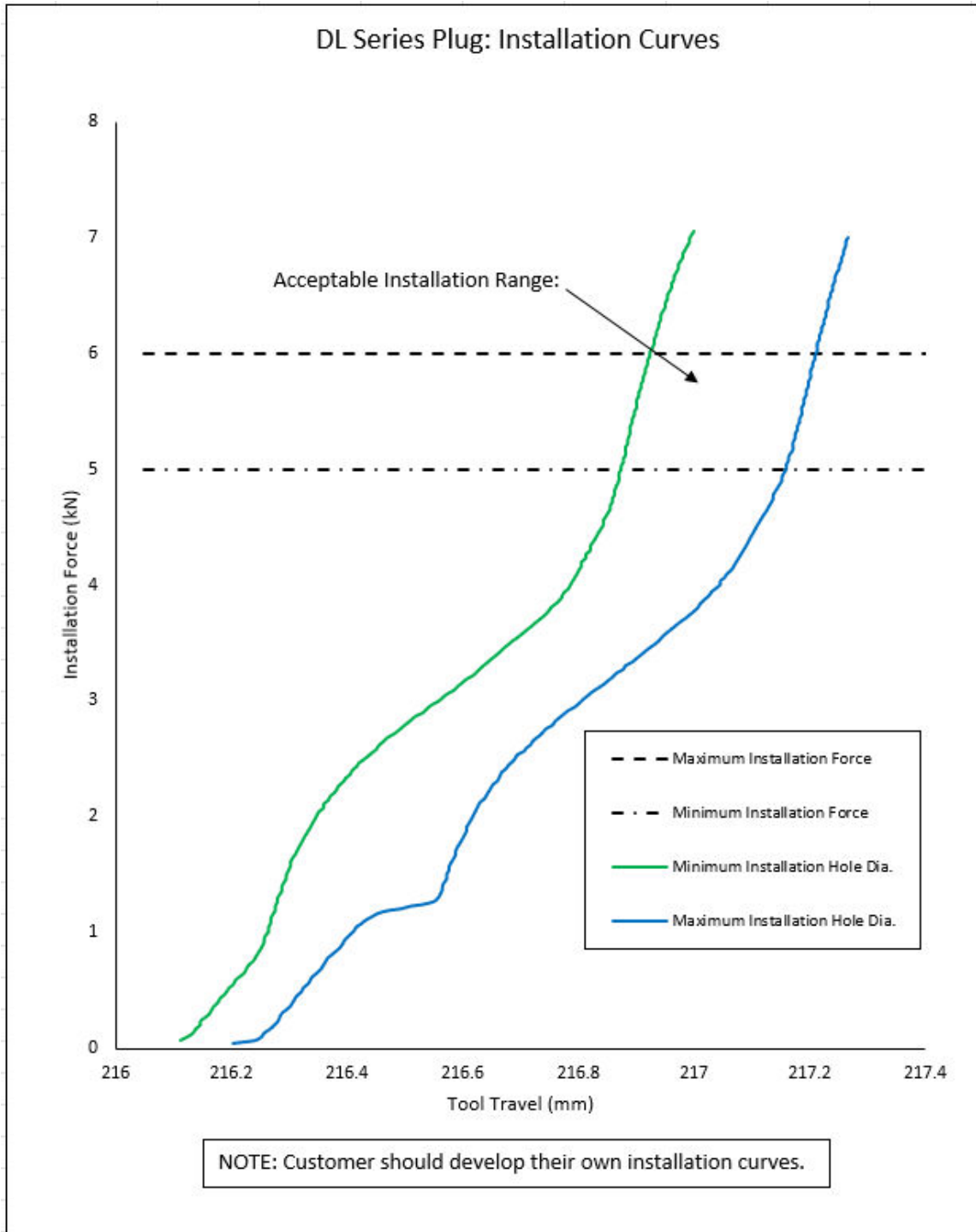

4.3 Appendix C: Installation Indicator Feature (Installation Photos)

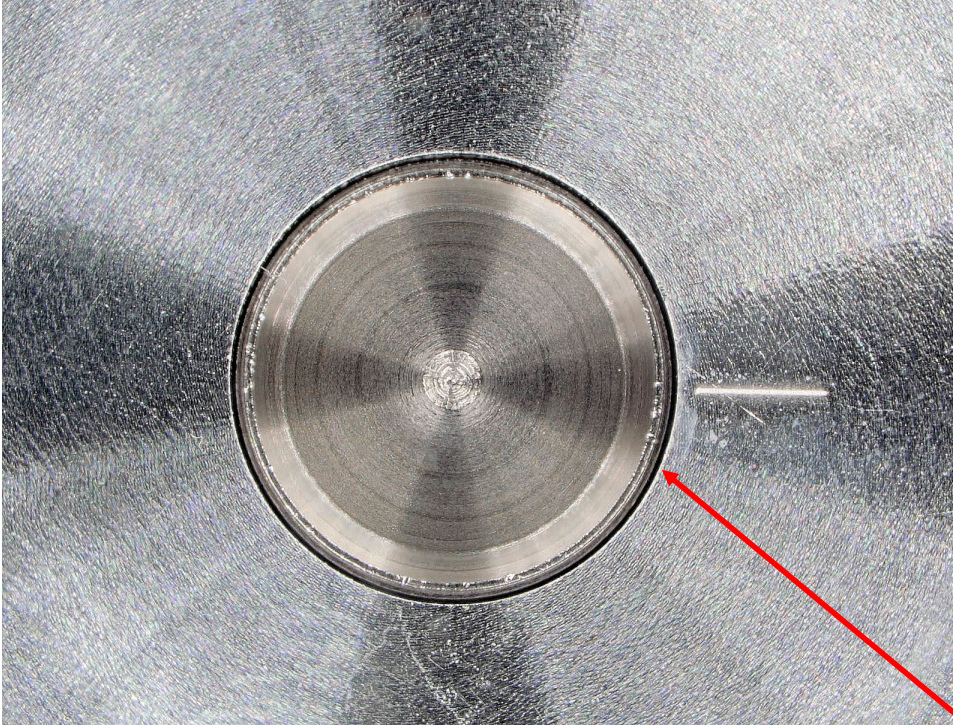

Photo 1: Plug placed in installation hole before installation process. Not installed.

Uninstalled gap
between
installation
indicator feature
and installation
hole.

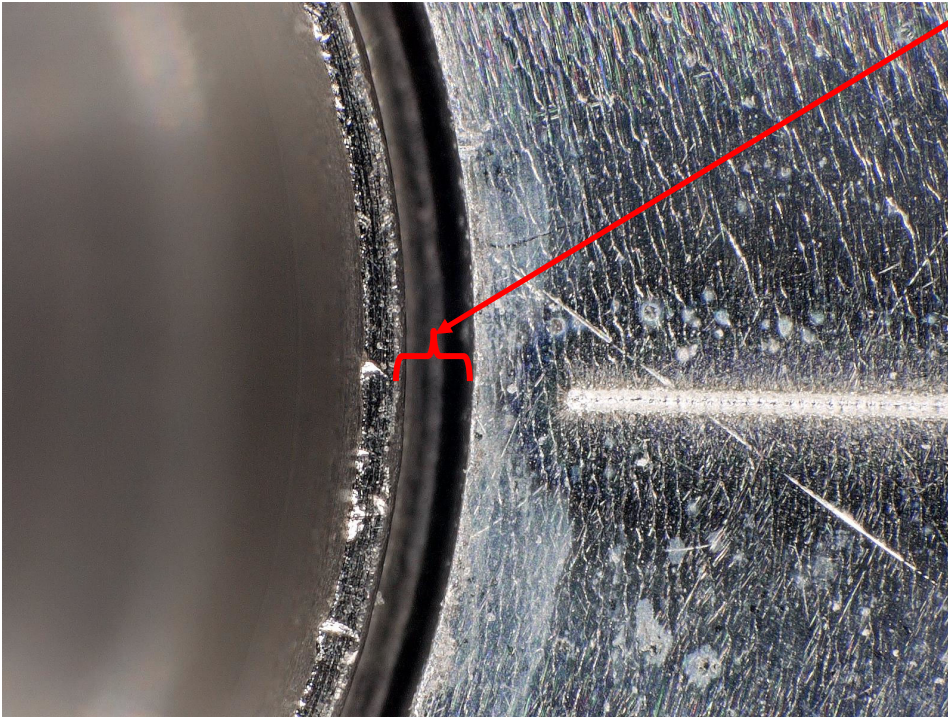

Photo 2: Plug placed in installation hole before installation process at 100x Magnification. Note the gap between the installation indicator feature on the plug and the installation hole (ref 0.2423 mm).

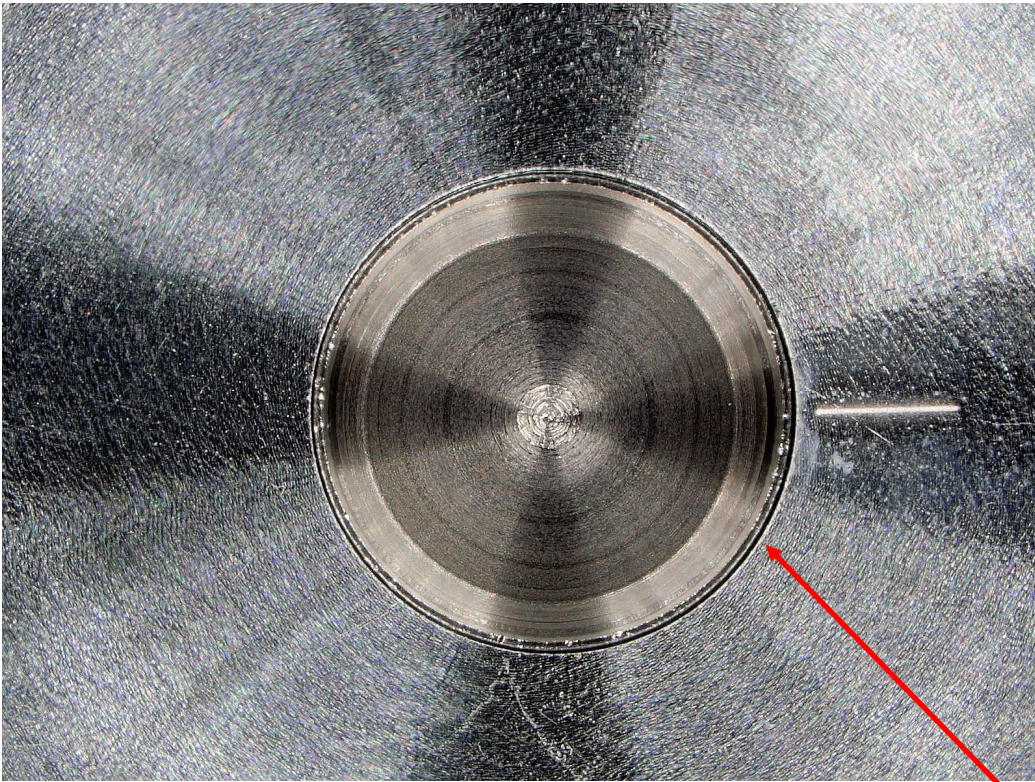

Photo 3: Incomplete Installation – Installation force applied to DL Series Plug, but not enough to fully seat the installation indicator feature.

Gap between installation indicator feature and installation hole.

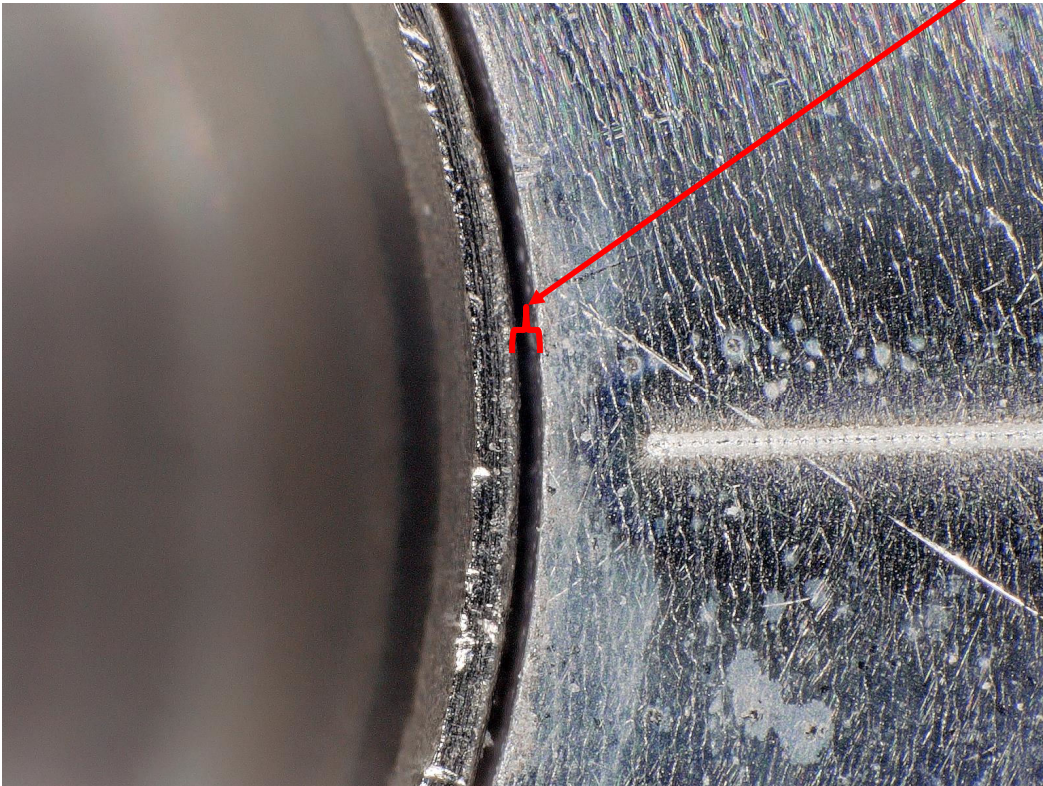
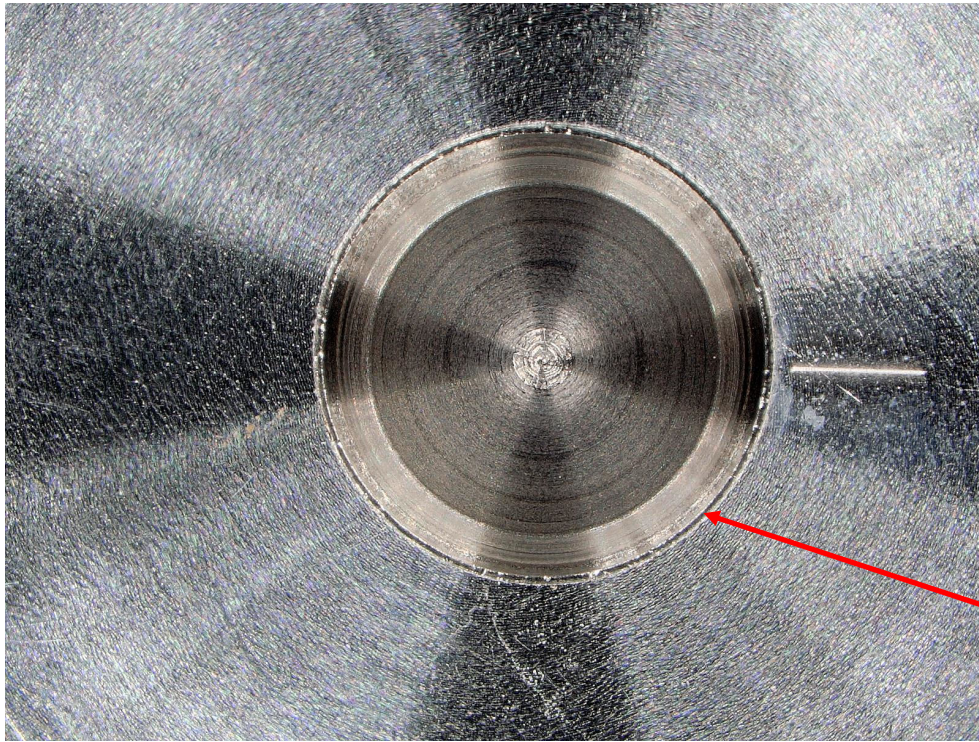

Photo 4: Incomplete Installation at 100x Magnification – Note there is a gap between the installation indicator feature and the installation hole (ref 0.0665 mm).



No gap between installation indicator feature and installation hole.

Photo 5: Complete Installation: no gap between installation indicator feature and installation hole.

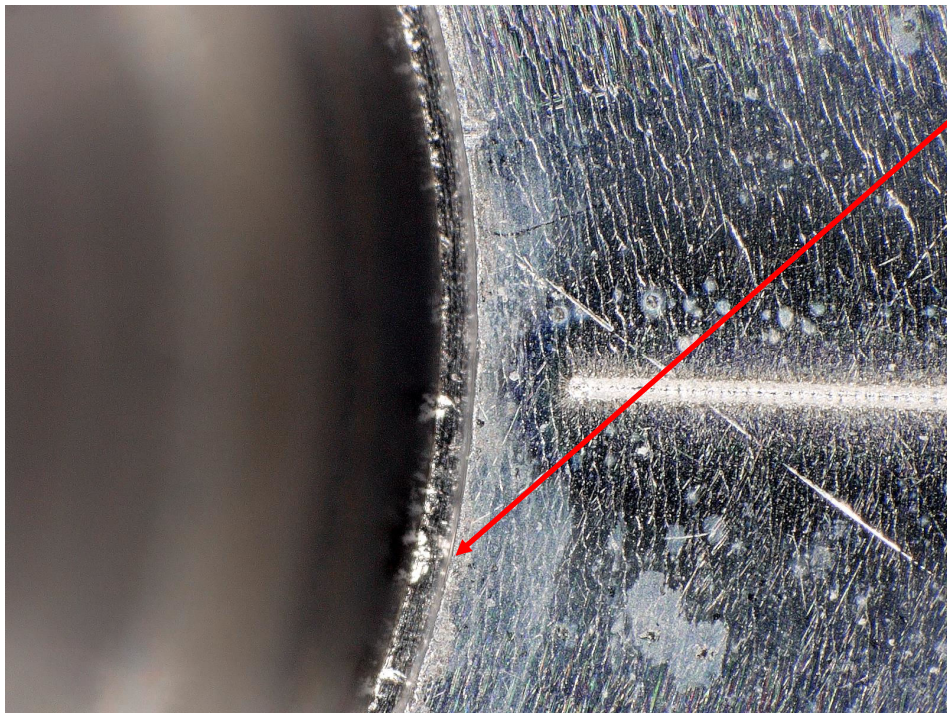
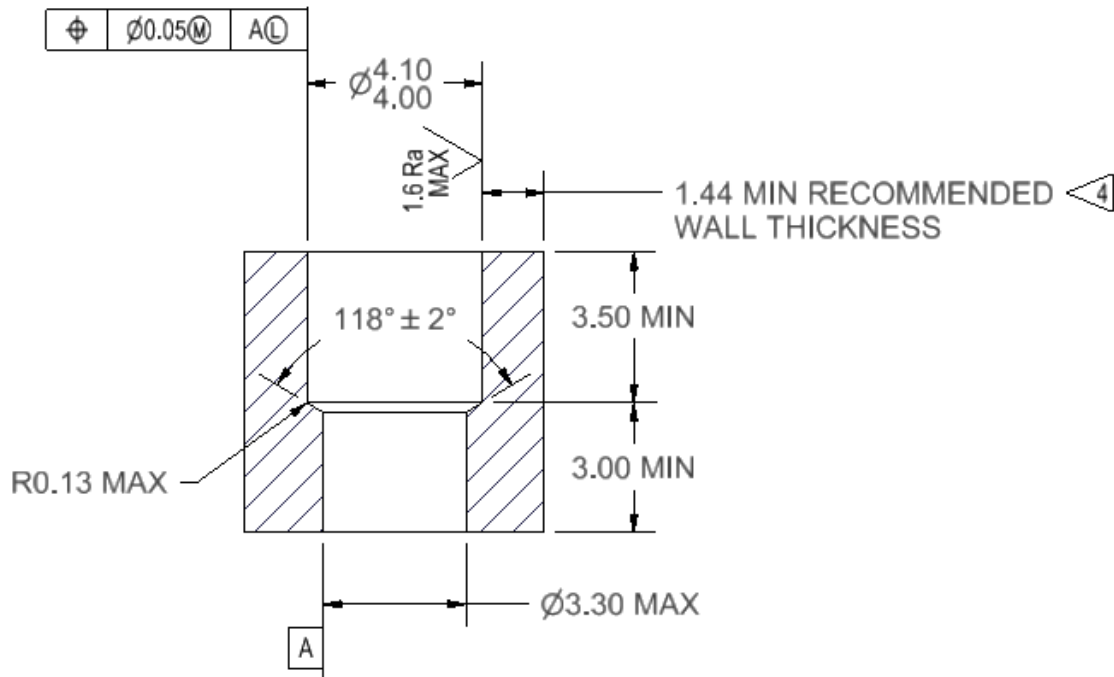

Photo 6: Complete Installation at 100x magnification: no gap between installation indicator feature and base material of installation hole.

4.3. Appendix D: Installation Hole



DIMENSIONS IN MILLIMETERS

NOTES:

1. HOLE SHOULD BE CLEAN, DRY AND FREE OF BURRS.
2. NO LONGITUDINAL SURFACE DEFECTS PERMITTED.
3. NO COATING OR SURFACE TREATMENTS IN THE AREA OF THE INSTALLATION HOLE WHERE THE PRODUCT IS TO BE INSTALLED.

- $\triangleleft 4$. THIS DIMENSION IS FOR CALCULATING MINIMUM MATERIAL REQUIRED FOR PLUG.

Refer to Lee Drawing No. 1INST114108S for complete specifications.

4.4. Appendix E: Installation Tool

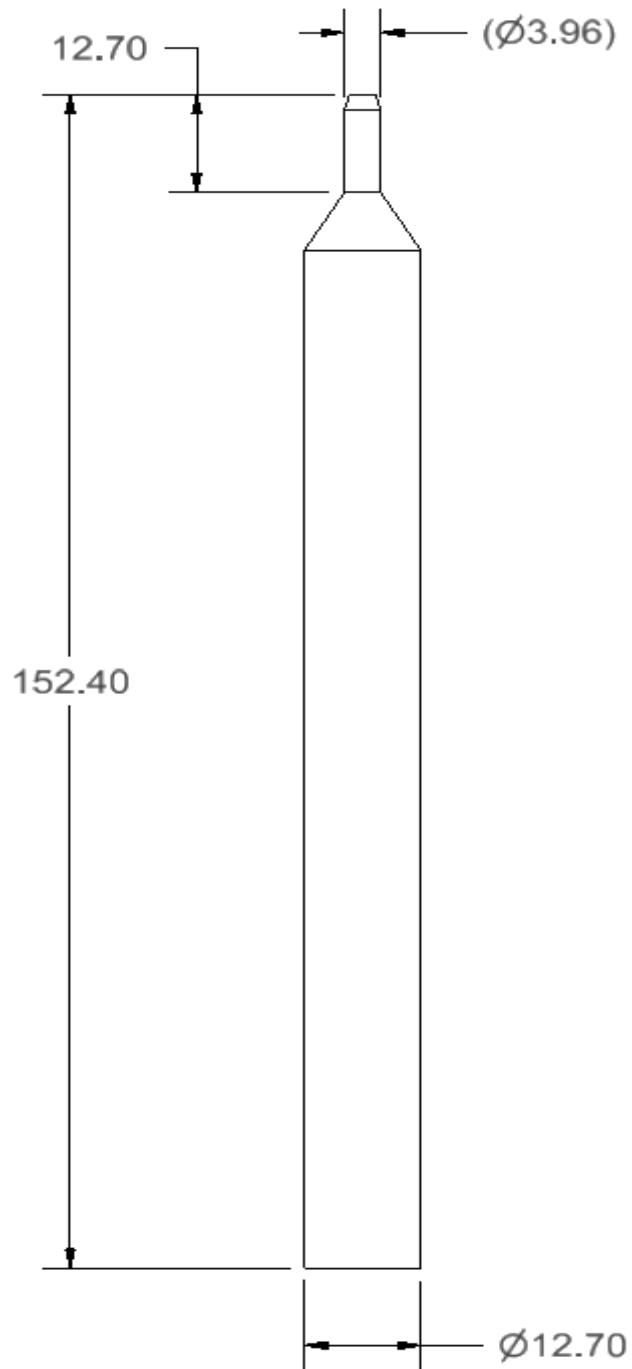

DIMENSIONS IN MILLIMETERS

Refer to Lee Part No. CCRT0400360S.

4.5. Appendix F: Promess, Inc. Press Information

Contact: Promess, Inc. 11429 Grand River Road, Brighton, MI 48116

Phone: (810) 229-9334, Web: www.promessinc.com

Press Information:

Number 8kN/200mm - FEMP12/200MP includes the following:

- 1-Press w/ integrated load cell, motor mounting plate and Motor
- 2-PreAmplifier (Connected to the Press Load Cell and Prox Switch)
- 3-MotionPRO Servo Amplifier
- 4-Motor Power Cable
- 5-Motor Encoder Cable
- 6-PreAmplifier Cable
- 7-MotionPRO software

